



PINSHENG Li-Ion Battery Pack BESS 500KWH 1MWH 2MWH Energy Storage System

Our Product Introduction

Basic Information

- Place of Origin: HUNAN ,CHINA
- Brand Name: pinsheng
- Certification: CE
- Model Number: PE-ESS-01
- Minimum Order Quantity: 1 SET
- Delivery Time: 25 WORKD DAYS
- Payment Terms: T/T
- Supply Ability: 3000+SETS+PER MONTH



Product Specification

- Product Nam: Solar Energy Storage System
- Rated Voltage: 300-600V
- Rated Capacity: 500KW-2MW
- Charging Current: Customized
- Discharge Current: Customized
- Operating Voltage: Customized
- Operating Temperature: -20 -60°C
- BMS: BMS+Relay
- Battery Cell: LFP
- Battery Type: Lithium Ion, LiFePO4, Other
- Highlight: **PINSHENG LI-Ion Battery Pack 500KWH, 2MWH Energy Storage System**

for more products please visit us on rechargeable-liionbattery.com

Company Display



PINSHENG
ENERGY

Hunan Pinsheng Energy Technology Co.,LTD



CERTIFICATE



LITHIUM BATTERY SUPER HIGH QUALITY AND RELIABLE



CUSTOMIZE
LOGO,CAPACITY,VOLTAGE&SIZE



PINSHENG
ENERGY

PROFESSIONAL OEM/ODM MANUFACTURER

Company Display

Hunan Pinsheng Energy Technology Co.,LTD

Hunan Pinsheng Energy Technology Co.,LTD located in Changsha City, Hunan Province, near to Guangzhou.

We focus on developing and producing Lithium battery and battery system integration, through many years development and research, we have formed a complete industry chain from research, production to sales.

Our lithium battery has the characteristics of longer cycle life, more higher security and more reliability, higher energy density and other superior performance.

Our products are widely used in energy storage system such as off grid wind & solar energy storage, telecommunication system, UPS and etc and power system such as electric motorcycles, electric bikes, E-scooter, electric tricycles, golf cart, fork lift,electric vehicles, and etc.

Pinsheng Energy Battery products has a good reputation at home and abroad, we has strict quality guarantee system to ensure high-quality products.

We put customers' needs at the first and listen to their suggestions.We continuously improve our product quality and services.

Pinsheng Energy is a competitive manufacturer in China, we are edicated to be a top OEM &ODM lithium battery manufacturer in the world.

Product name	Solar Energy Storage System
Rated voltage	200V-600V
Rated Capacity	500Ah-2000Ah
Size	L5.8m x W2.4m xH2.4m
Charging cut-off voltage	200-600V or Customized
Discharge cut-off voltage	200-600V or Customized
Charging current	Customized
Discharge current	Customized
Operating Voltage	Customized
Operating temperature	20-60°C

Detail display



Product Features

Super High Quality

Design for 10 years shelf life

With Smart BMS / EMS and Super Safety Design

all design is basic for good use and safety solar generation and battery storage system

Wide range of temperature

Reliable performance in wide range service temperature

Support Customization

Support OEM&ODM and customize voltage and capacity

Support Multiple communication

Support RS485, Ethernet and etc communication

With recording function

Complete fault and operation log recording function



Application scenario



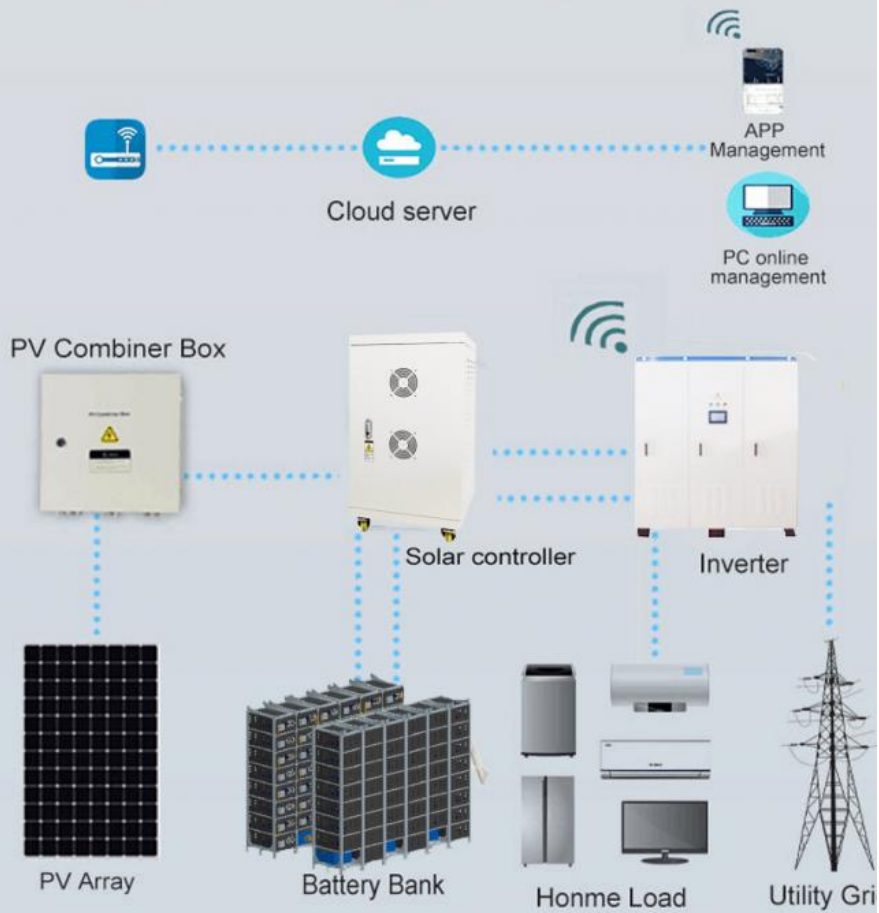



Intelligent Solar Energy Management System



PROJECT CASE



PRODUCT SPECIFICATION

No.	Model	Picture	Description	Qty.
1	Solar Panel		Mono Power: 540W Voltage(Vmp): 41.65V Voltage(Voc): 49.5V Connection: 15pcs in series as a string, 180 strings in parallel	2700
2	PV Combiner Box		18 input 1 output (Switches, Breaker, SPD) 1 pcs box connect with 1 unit controller	10
3	Battery		588.8V 450AH battery group	
4	Solar charge Controller		Solar power: 150KW MPPT Mode Rated voltage: 600Vdc Charge current: 250A LCD display 2pcs in parallel Optional: RS485/Wifi/GPRS 1 PV input	10
5	Wifi/GPRS/Ethernet		Wifi/GPRS(2G/3G) GPRS(4G)	4 4
6	PCS		Nominal Power: 500KW DC input: 500-750V Out put: AC380/400/415V 50HZ/60HZ 2 units in parallel (without load terminals)	2

OFF GRID SOLAR POWER SYSTEM DIAGRAM

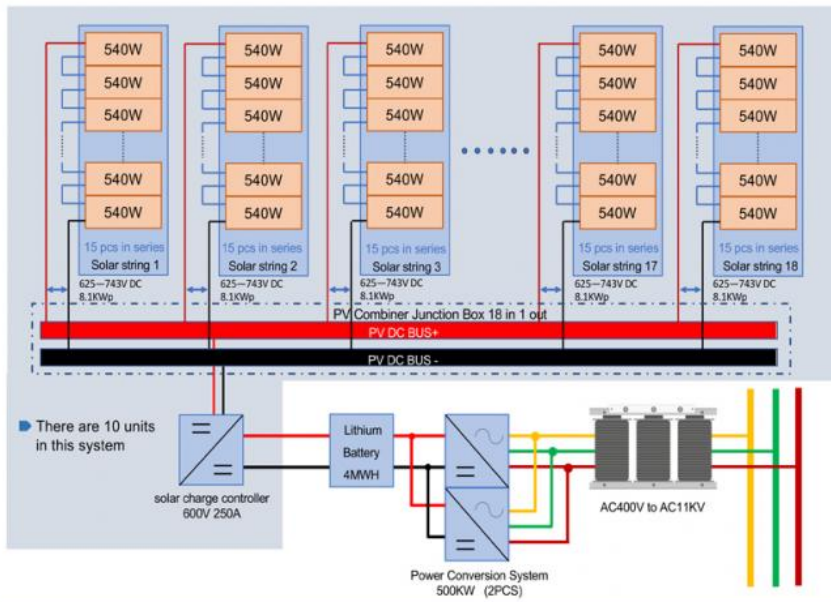

WHY CHOOSE US?

Competitive edge



Professional Manufacturing Solutions



Maximum 5 Years Warranty



Low Moq With Competitive Price



Have a complete after- sale service



With us, you will get low factory price at low Moq requirement;



With us, you will get a complete power solutions



With us, you will get convenience shipping worldwide.

WE CAN DO IT



Our advantage :

- ✓ high efficiency development based on our strong team
- ✓ supply goods with lowest price
- ✓ high quality service



Our promise :

- ✓ professional service for customer , provide correct sample quickly
- ✓ supply high quality standard
- ✓ delivery goods on time

PAYMENT&LOGISTICS

LOGISTICS

BY AIR / BY SEA / EXPRESS / UPS / FEDEX / DHL



Trade Assurance

T/T



L/C

PayPal



VISA

FAQ

Q1 Can you give me a discount ?

A: We are manufactory , our policy is that bigger quantity , cheaper price , so we will give you discount according to your order quantity

Q2 The shipping cost is too high , can you give me more cheaper ?

A: When we calculate the shipping cost for you . we will use the cheapest and safest courier .and it is shipping company who ask us to pay , we cant gie you cheaper , pls kindly understand But we can promise that we will not ask you to pay more shipping cost , if u think it is too expensive , you can use your own shipping company . it is ok for us .

Q3 Can you offer free shipping ?

A: For we are manufacturer, we have given the cheapest price as we can,and we did not add shipping cost into the products cost , so we cant offer free shipping , pls kindly understand , tks .

Contact Us



PINSHENG
ENERGY



Sofia Tse

Sales Manager

Hunan Pinsheng Energy Technology Co.,LTD

2/F, Building 4, Xiangfeng High-Tech Industrial Park, Changsha
County, Changsha City, Hunan Province
M.P.: +86-15675831763/13307465388
P.C: 410100
E-Mail: sofia_tse210816@gmail.com



PINSHENG
ENERGY

Hunan Pinsheng Energy Technology Co.,LTD



Hunan Pinsheng Energy Technology Co., LTD.



15616151876



info@pinshengenergy.com



rechargeable-liionbattery.com

NO. 259, Lixiang East Road, Xiangfeng Technology Industry Park, Changsha City, Hunan, China.

