



## Photovoltaic Solar Power System Solar Panel Hybrid Grid Kit 5KW 10kw Home Use

Our Product Introduction

for more products please visit us on [rechargeable-liionbattery.com](http://rechargeable-liionbattery.com)

### Basic Information

- Place of Origin: Hunan, China
- Brand Name: Picell, Neutral or OEM
- Model Number: PE-S10KW
- Minimum Order Quantity: 1 set
- Price: USD4500~4600/Set
- Packaging Details: customary packing
- Delivery Time: 20days
- Payment Terms: L/C, D/A, D/P, T/T, Western Union, MoneyGram
- Supply Ability: 30000 set/month



### Product Specification

- Load Power (W): 10KW
- Controller Type: MPPT Solar Charge Controller
- Mounting Type: Ground Mounting, Roof Mounting, Carport Mounting
- Output Frequency: 50/60hz
- Configuration: Customized Hybrid System
- Battery Capacity: Can Be Customized
- Output Voltage (V): 110v/220v/230v/240v
- Application: Home
- Work Time: Depend On Sunshine Duration
- Max Efficiency: 97.5%
- Highlight: **10KW Solar Panel Hybrid Grid Kit, 5KW Photovoltaic Solar Power System, Home Use Photovoltaic Solar Power System**

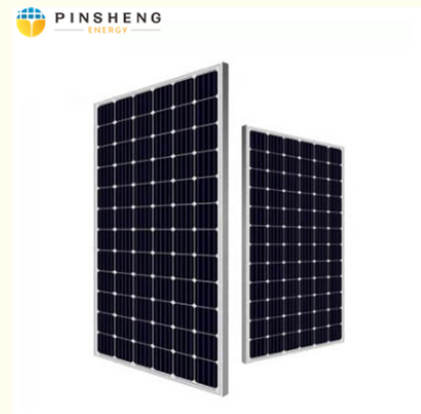

### More Images

PINSHENG ENERGY



PINSHENG ENERGY



PINSHENG ENERGY

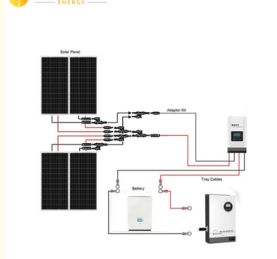

# Product Application



\* No blocking light and exterior scenery, no battery shadow in the room, no uneven

lighting, not easy to cause visual fatigue, beautiful design, complex **modern aesthetic**.

\* Photovoltaic glass can **block the sun** and **reduce the direct exposure to**

**ULTRAVIOLET rays**.

\* Provide electricity for household appliances.

\* **Save electricity bills**, and sell surplus electricity to the grid company to **make money**.

\* Whether in the cold winter or in the hot summer, the photovoltaic solar room can

create a **comfortable** \*and **healthy space** for you and your family.

\* It is your **best choice** for entertainment, sports, rest, reception and leisure.



## Exquisite garden lamp

- 1.Into light energy
- 2.Electricity saving exquisite
- 3.Green environmental protection
- 4.High safety factor

## Car Port Installation

\*It can supply power for new energy vehicles, which is convenient, environmental friendly and energy efficient







### Snow Plateau

- \*Excellent performance, can adapt to different geographical terrain
- \*Meet the needs of most countries and regions in the world

### Farm

- \*Farm power generation
- \*Energy saving
- \*Green environmental protection
- \*Meet a large number of electricity demand



### Industrial Power Generation

- \* Solar power generation
- \*Environmental protection
- \*Cost saving

# System Composition

## Solar photovoltaic power generation

Use solar cells to directly convert solar energy into electricity. Photovoltaic

power generation system is mainly composed of solar cells, batteries, controllers and inverters, of which the solar cell is a key part of photovoltaic power generation system, the quality and cost of solar panels will directly determine the quality and cost of the whole system.

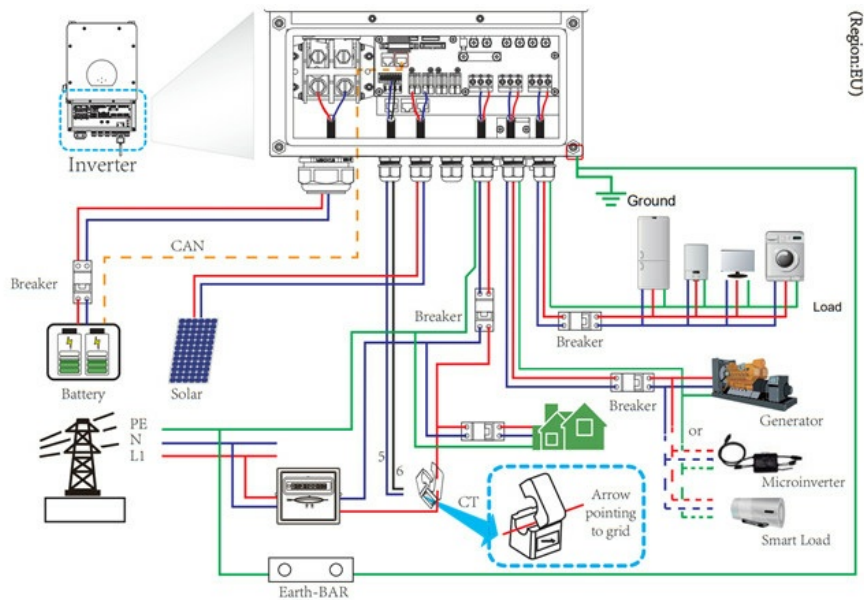

# configurations

## Mounting bracket (optional)

- \*Residential roof (pitched roof)
- \*Commercial roof (flat roof & workshop roof)
- \*Ground solar mounting system
- \*All aluminum structure solar mounting system



## Solar Panels

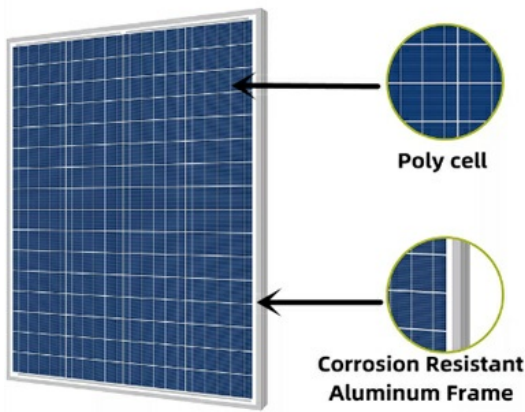

- \*High Efficiency Cells Anti-Pid
- \* Mono/Poly Standard/Half Cell Panels
- \* High Efficiency with PERC panels available
- \* 10 years warranty with 80% power output
- \* PID Resistant, High salt and ammonia resistance

## PV Mounting System

1. Ground Solar Mounting System
2. Residential Roof(Pitched Roof)
3. Car parking solar mounting system
4. Vertical wall solar mounting system
5. Commercial Roof(Flat roof&workshop roof)
6. All aluminum structure solar mounting system
7. Ballasted mount, Do not harm the roof structure.

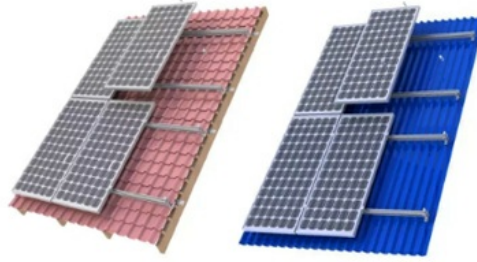

## Solar Storage Battery

- \*48V 100ah 150ah 200ah Battery Optional
- \*Lithium ion LifePO4 Module or Powerwall Optional
- \*Has excellent performance and longer life-span
- \*Higher energy density,smaller volume for household
- \*All-time Monitor safety for home
- \*Fast installation and convenient design

## PV array combiner box

- \*Applicable for outdoor PV systems
- \*Number of PV input array: 6
- \* Max input pv current each array: 16A
- \*Max output current: 96A, 600Vdc
- \*Lighting Protection, it reduces solar cable IP65







### Toolkit

- \*Wire Cable Cutter & Stripper,
- \*MC3 MC4 Crimper
- \*MC4 Compatible /MC4 EV02/TS4\*
- \*Disassembly Tool
- \*500N Tensile Strength Female/Male/Fuse

### Hybrid On Grid Inverter

- \*Hybrid On Grid Inverter
- \*Rated Power 2kw-10kw
- \*Build in Mppt solar charge controller
- \*Low and High Voltage with BMS Multi Protection
- \*Wide AC input 170~280V/90~280V
- \*Auto Frequency sensing 50Hz/60Hz



## Product Advantage



### Monocrystalline silicon solar cells

Monocrystalline silicon solar cells typically have a service life of 15 years and up to 25 years. The photoelectric conversion efficiency of monocrystalline silicon solar cells is about 15% and up to 23%, which is the highest among solar cells .

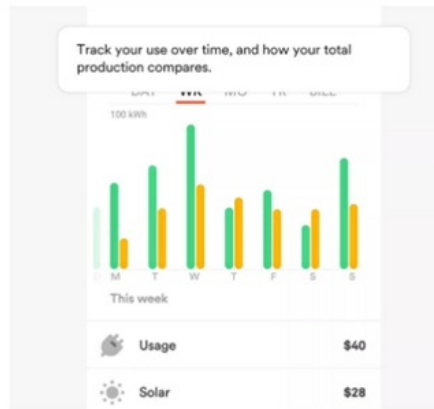
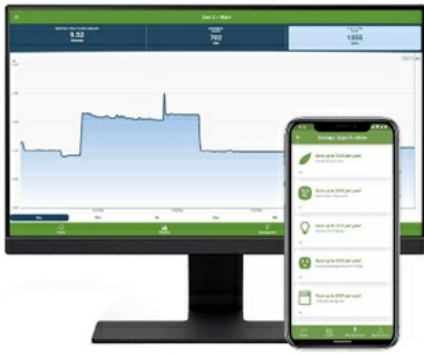

### Data Logging Stick

Allows you to receive information from solar power system, in order to keep you informed about the situation of your PV system, and the atmosphere conditions, everywhere and every time, thanks to our web server, accessible via Wi-Fi, Lan or GPRS. App Available for PC, IOS & Andriod



### Easy to install

You can install yourself, save time and effort, suitable for different roof structures, to meet the needs of different consumers





### **Adapting to extreme weather**

\*PID Resistant, High salt and ammonia resistance

\*Low temperature and high temperature resistance

**parameter**



Item	5KW	10KW
Half Cell Solar Panel	12 pieces	24 pieces
PV Combiner Box	1 inputs 1output	2 inputs 2outputs
Hybrid Off Grid Inverter	5kw	10kw
WIFI Module Monitor	1 set	1 set
Solar Battery	GEL/Lithium Powerwall with BMS	GEL/Lithium Powerwall with BMS
PV Cable	6mm2	6mm2
Mounting Bracket	Tile Roof/Ground	Tile Roof/Ground
MC4 Connector	12pcs	24pcs
Installation Tool Box	1set	1set
Installation Manual	Yes	Yes

# Company Display



## CERTIFICATE





# FAQ

## Q1 Can you give me a discount ?

**A:** We are manufactory , our policy is that bigger quantity , cheaper price , so we will give you discount according to your order quantity

## Q2 The shipping cost is too high , can you give me more cheaper ?

**A:** When we calculate the shipping cost for you . we will use the cheapest and safest courier .and it is shipping company who ask us to pay , we cant gie you cheaper , pls kindly understand But we can promise that we will not ask you to pay more shipping cost , if u think it is too expensive , you can use your own shipping company . it is ok for us .

## Q3 Can you offer free shipping ?

**A:** For we are manufacturer, we have given the cheapest price as we can,and we did not add shipping cost into the products cost , so we cant offer free shipping , pls kindly understand , tks .

# WE CAN DO IT



## Our advantage :

- ✓ high efficiency development based on our strong team
- ✓ supply goods with lowest price
- ✓ high quality service



## Our promise :

- ✓ professional service for customer , provide correct sample quickly
- ✓ supply high quality standard
- ✓ delivery goods on time

## PAYMENT&LOGISTICS

### LOGISTICS

BY AIR / BY SEA / EXPRESS / UPS / FEDEX / DHL



### Trade Assurance

T/T



L/C

PayPal



VISA



## Hunan Pinsheng Energy Technology Co., LTD.



15616151876



info@pinshengenergy.com



rechargeable-liionbattery.com

NO. 259, Lixiang East Road, Xiangfeng Technology Industry Park, Changsha City, Hunan, China.